



**PATENTSTYRET**  
Styret for det industrielle rettsvern

nr 3 - 2005.01.31 NO

årgang 4

ISSN 1503-5808

Norsk

# design tidende

[www.patentstyret.no](http://www.patentstyret.no)

Norsk designtidende er en publikasjon som inneholder kunngjøringer innenfor designområdet

**BESØKSADRESSE**

- ▶ Københavngaten 10

**POSTADRESSE**

- ▶ Postboks 8160 Dep.  
0033 Oslo

**E-POST** [mail@patentstyret.no](mailto:mail@patentstyret.no)

**TELEFON**

- ▶ 22 38 73 00

**TELEFAKS**

- ▶ 22 38 73 01

**INFOSENTERETS TELEFONTID**

- ▶ kl. 09.00 - 15.00
- ▶ Telefon (+47) 22 38 73 33
- ▶ Telefax (+47) 22 38 73 31

## Innholdsfortegnelse

Registrert design .....	side 3
Fornyelse av registreringer .....	» 28

## REGISTRERT DESIGN

*I henhold til designloven § 18 første ledd i.f. kunngjøres i dag følgende registrerte design.*

Det kan fremsettes krav om at designregistreringen helt eller delvis skal oppheves, jf designloven §§ 25 flg. og designforskriften §§ 26 flg.

Designregistreringen gjelder for den eller de periodene på fem år som søknaden er innlevert for, regnet fra søknadsdagen. Registreringen kan fornyes, jf designloven §§ 23 og 24. Maksimal beskyttelsestid er 25 år. For reservedeler, se unntaket i designloven § 23 annet ledd.

### Reg.nr: 78436

Søkn.nr: 20030646

Inngitt: 2003.11.21

Allm. tilgj.: 2004.05.21

Reg.dato: 2005.01.03

Kunngjort: 2005.01.31

Reg. gjelder til: 2008.11.21

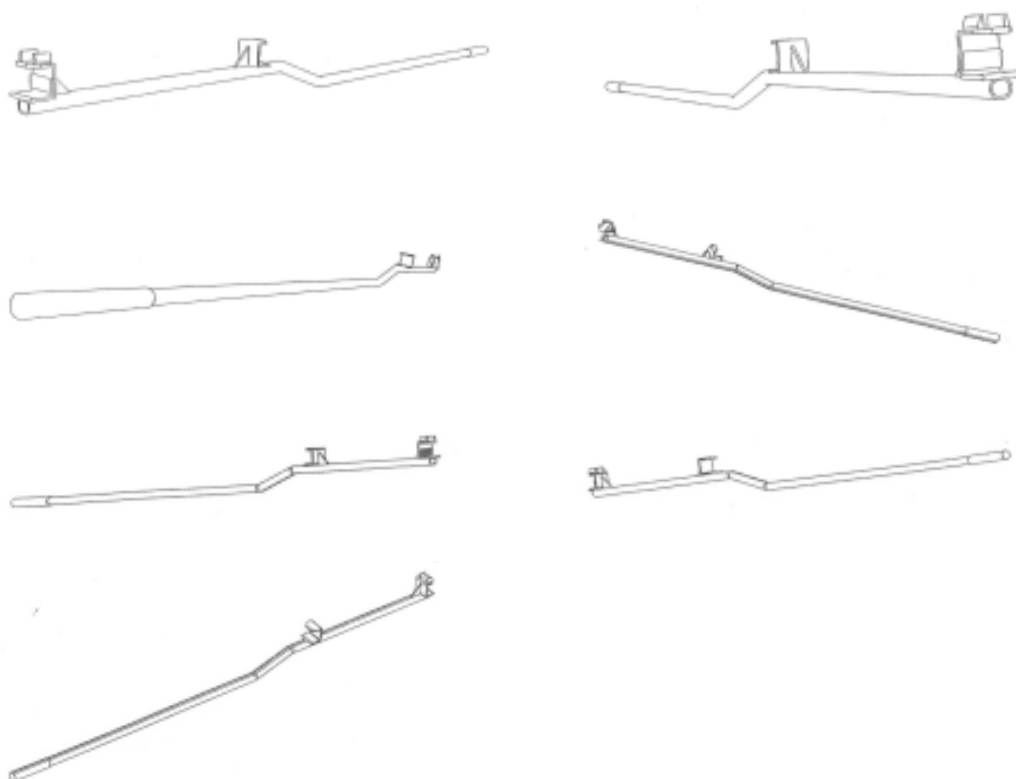

Produkt: Verktøy for montering av stillaser og liknende, klasse 8-05.  
Innehaver: Haki AB, Box 102, 280 63 Sibbhult, SE  
Fullmektig: Bryn Aarflot AS, Postboks 449 Sentrum, 0104 Oslo, NO  
Designer: Ingvar Martinsson, c/o HAKI AB, 280 63 Sibbhult, SE

**Reg.nr: 78437**

Søkn.nr: 20030561

Inngitt: 2003.10.22

Allm. tilgj.: 2004.04.22

Reg.dat: 2005.01.04

Kunngjort: 2005.01.31

Reg. gjelder til: 2008.10.22



Produkt: Emne for eske, klasse 9-03.

Innehaver: Glaxo Group Ltd, Glaxo Wellcome House, Berkeley Avenue, UB60NN Greenford Middelsex, GB

Fullmektig: Zacco Norway AS, Postboks 765 Sentrum, 0106 Oslo, NO

Designer: Judy Jo Gibbs, c/o GlaxoSmithKline, 1011 North Arendell Avenue, NC27597 Zebulon, US, Philippe Bruno Ragot, c/o GlaxoSmithKline, 1011 North Arendell Avenue, NC27597 Zebulon, US, Jeffrey Michael Schons, c/o GlaxoSmithKline, 1011 North Arendell Avenue, NC27597 Zebulon, US, Hong Helen Ye, c/o GlaxoSmithKline, Five Moore Drive, NC27709 Research Triangel Park, US

**Reg.nr: 78438**

Søkn.nr: 20030718

Inngitt: 2003.12.29

Allm. tilgj.: 2004.01.03

Reg.dat0: 2005.01.05

Kunngjort: 2005.01.31

Reg. gjelder til: 2008.12.29



1.1



1.2



1.3



1.4



1.5



1.6



1.7



2.1



2.2



2.3



2.4



2.5



2.6



2.7



3.1



3.2



3.3



3.4



3.5



3.6



3.7

Produkt: 1. Del til kaffekvern, 2. Kaffekvern, 3. Kaffekvern, klasse 7-04.  
Innehaver: Smitdesign BV, Industrieweg 20, 3958VR Amerongen, NL  
Fullmektig: Oslo Patentkontor AS, Postboks 7007 Majorstua, 0306 Oslo, NO  
Designer: Gerard Clement Smith, Industrieweg 20, 3958VR Amerongen, NL  
Prioritet: 2003.07.03, EM, 000048376  
Anmerkning: Registreringen gjelder samregistrering.

**Reg.nr: 78439**

Søkn.nr: 20040021

Inngitt: 2004.01.20

Allm. tilgj.: 2004.07.20

Reg.dat0: 2005.01.05

Kunngjort: 2005.01.31

Reg. gjelder til: 2009.01.20

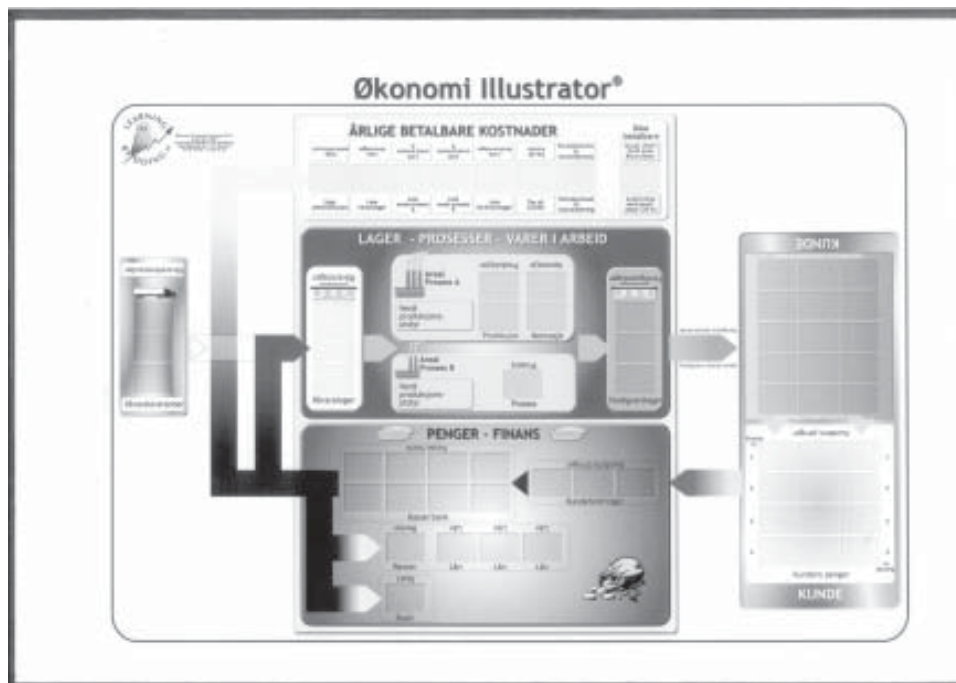

Produkt: Undervisningsmateriell, klasse 19-07; Skjermbilde, klasse 14-04

Innehaver: Learning By Doing AS, Postboks 78, 3164 Revetal, NO

Designer: Alf Kirkeberg, Oprand, 3175 Ramnes, NO, Stian Kirkeberg, Oprand, 3175 Ramnes, NO

Reg.nr: 78440

Søkn.nr: 20030700

Inngitt: 2003.12.12

Allm. tilgj.: 2003.12.13

Reg.dat: 2005.01.05

Kunngjort: 2005.01.31

Reg. gjelder til: 2008.12.12



1.1



1.2



1.3



1.4



1.5



1.6



2.1



2.2



2.3



2.4



2.5



3.1



3.2



4.1



4.2





5.1



5.2



5.3



5.4

- Produkt:** 1. Hodetelefon, klasse 14-01 og 14-03; 2. Mobiltelefon, klasse 14-03; 3. Del til mobiltelefon, klasse 14-03; 4. Tastaturarrangement til mobiltelefon, klasse 14-03; 5. Del til mobiltelefon; klasse 14-03.
- Innehaver:** Nokia Corp, Keilalahdentie 4, 02150 Esbo, FI
- Fullmektig:** AS Bergen Patentkontor, Postboks 1998 Nordnes, 5817 Bergen, NO
- Designer:** Valtteri Eroma, Valopoiju 2A27, 02320 Esbo, FI (Design nr. 1)  
Sami Lehtovaara, Suovasentie 52, 21250 Masku, FI (Design nr. 1)  
Junichi Kagami, 4-26-7, Akatsutsumi, Setagaya-ku, 156-004 Tokyo, JP (Design nr. 2-5)  
Todd Wood, 1544 12th Street #202, CA90401 Santa Monica, US (Design nr. 2-5)  
Paresh Desai, 13900 Panay Way #M220, CA90292 Marina del Rey, US (Design nr. 2-5)  
Robert Shepherd, 5830 Reseda Boulevard #143, CA91356 Tarzana, US (Design nr. 2-5)
- Prioritet:** 2003.06.13, FI, 20030170 (Design nr. 1)  
2003.06.13, US, 183524 (Design nr. 2)  
2003.06.13, US, 183521 (Design nr. 3, 4, 5)
- Anmerkning:** Registreringen gjelder samregistrering.

**Reg.nr: 78441**

Søkn.nr: 20030509

Inngitt: 2003.09.30

Allm. tilgj.: 2003.10.01

Reg.dato: 2005.01.06

Kunngjort: 2005.01.31

Reg. gjelder til: 2008.09.30



1.1



1.2



1.3



1.4



2.1



2.2



2.3



2.4



3.1



3.2



3.3



3.4



4.1



4.2

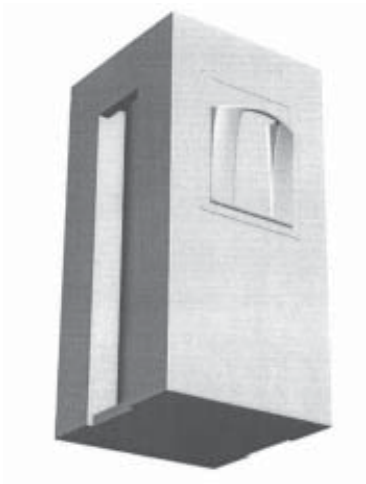

4.3



4.4



5.1



5.2



5.3



5.4



6.1



6.2



6.3



6.4



7.1



7.2



7.3

Produkt: 1-7. Innkassenhet for avfallssystem, klasse 25-02.  
Innehaver: Envac Centralsug AB, 1784 Stockholm, SE  
Fullmektig: Protector IP Consultants AS, Postboks 5074 Majorstua, 0301 Oslo, NO  
Designer: Calle Medin, Roslagsgatan 24, 11355 Stockholm, SE,  
Kjell Eldered, Hanskrokavägen 4, 13465 Stockholm, SE  
Prioritet: 2003.04.01, EM, 08537001007  
Anmerkning: Registreringen gjelder samregistrering

**Reg.nr: 78442**

Søkn.nr: 20030638

Allm. tilgj.: 2003.11.20

Kunngjort: 2005.01.31

Inngitt: 2003.11.18

Reg.dato: 2005.01.06

Reg. gjelder til: 2008.11.18

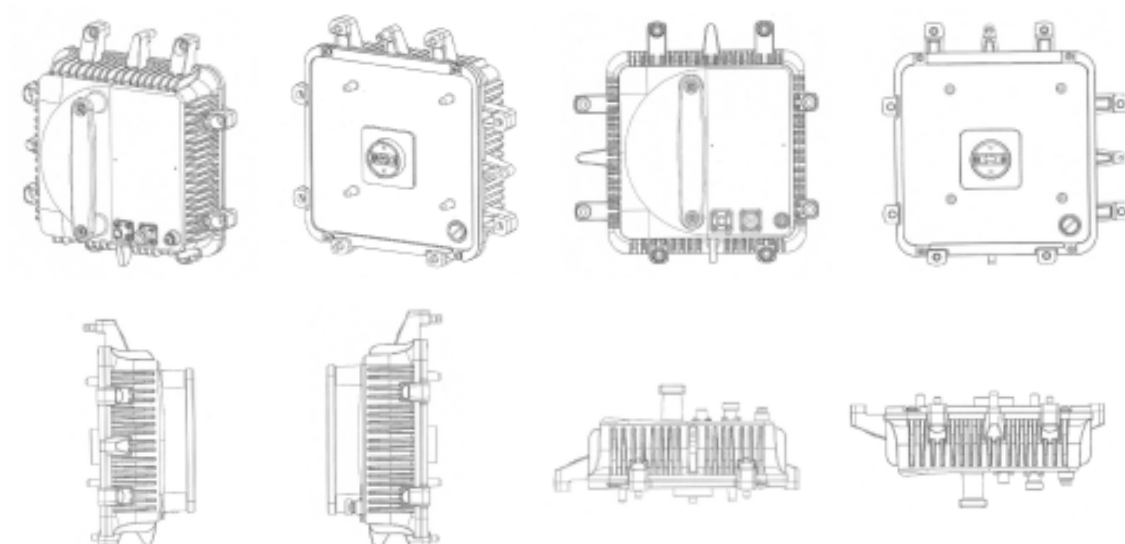

Produkt: Kommunikasjonsapparat, klasse 14-03.  
Innehaver: Nec Corp, 7-1, Shiba 5-chome, Minato-ku, 108-8001 Tokyo, JP  
Fullmektig: Zacco Norway AS, Postboks 765 Sentrum, 0106 Oslo, NO  
Designer: Yukihiro Yokoyama, c/o NEC Corp, 7-1, Shiba 5-chome, Minato-ku, Tokyo, JP  
Hiroyuki Yoshida, c/o NEC Wireless Networks Ltd, 1-1, Aza Ipponmatsu, Shimizumachi, Fukushima-shi, Fukushima, JP  
Mitsuhiro Okabe, c/o NEC Wireless Networks Ltd, 1-1, Aza Ipponmatsu, Shimizumachi, Fukushima-shi, Fukushima, JP  
Iwao Ouchi, c/o NEC Design Ltd, 20-36, Takanawa 2-chome, Minato-ku, Tokyo, JP  
Prioritet: 2003.05.20, JP, 2003/13872

**Reg.nr: 78443**

Søkn.nr: 20040417

Inngitt: 2004.07.29

Allm. tilgj.: 2004.07.29

Reg.dat: 2005.01.06

Kunngjort: 2005.01.31

Reg. gjelder til: 2009.07.29



Produkt: Redskap for krabbefiske, klasse 22-05.

Innehaver: Jesper Koch, Första Långgatan 6 A, 41303 Göteborg, SE

Designer: Jesper Koch, Första Långgatan 6 A, 41303 Göteborg, SE

Prioritet: 2004.06.30, SE, 0477570

**Reg.nr: 78444**

Søkn.nr: 20030230

Allm. tilgj.: 2003.04.11

Kunngjort: 2005.01.31

Inngitt: 2003.04.10

Reg.dat: 2005.01.06

Reg. gjelder til: 2008.04.10

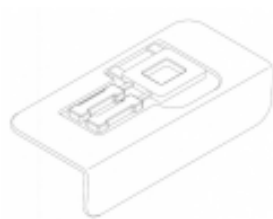

1.1

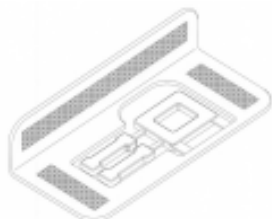

1.2



1.3

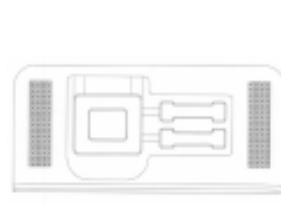

1.4



1.5

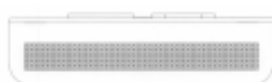

1.6



1.7



2.1



2.2

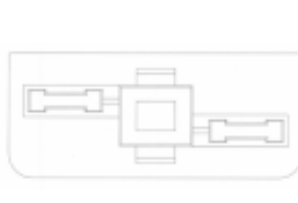

2.3

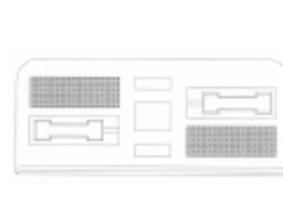

2.4



2.5



2.6



2.7

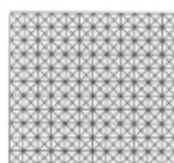

3.1



3.2

Produkt: 1. Kantbeskyttelse for emballasje, 2. Kantbeskyttelse for emballasje, 3. Friksjonsflate til kantbeskyttelse for emballasje, klasse 9-99.

Innehaver: Inter Ikea Systems BV, Olof Palmestraat 1, 2616LN Delft, NL

Fullmektig: Onsagers AS, Postboks 6963 St Olavs plass, 0130 Oslo, NO

Designer: Allan Dickner, Storkstigen 16, 34335 Älmhult, SE

Prioritet: 2002.10.11, SE, 021484

Anmerkning: Registreringen gjelder samregistrering.

**Reg.nr: 78445**

Søkn.nr: 20040013

Allm. tilgj.: 2004.01.13

Kunngjort: 2005.01.31

Inngitt: 2004.01.13

Reg.dat: 2005.01.06

Reg. gjelder til: 2009.01.13



1.1

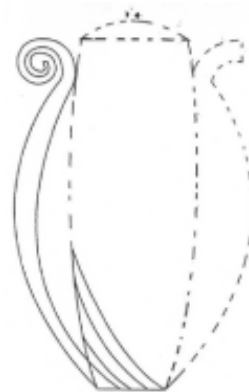

2.1

Produkt: 1. Hank til servise, 2. Hank til servise, klasse 7-01.  
Innehaver: Tekstilkreativ Sol Bækholt, Postboks 237, 1322 Høvik, NO  
Fullmektig: Patentspesialisten Dahl Sandbu, Hiltonåsen 54, 1341 Slependsen, NO  
Designer: Sol B Bækholt, Postboks 237, 1322 Høvik, NO  
Anmerkning: Registreringen gjelder samregistrering.



**Reg.nr: 78446**

Søkn.nr: 20020761

Allm. tilgj.: 2003.05.29

Kunngjort: 2005.01.31

Inngitt: 2002.12.09

Reg.dat: 2005.01.06

Reg. gjelder til: 2007.12.09



Produkt: Klokke, klasse 10-02.

Innehaver: Asprey Holdings Ltd, 167 New Bond Street, London W1S 4AS, England, GB

Fullmektig: Bryn Aarflot AS, Postboks 449 Sentrum, 0104 Oslo, NO

Designer: Thierry de Baschmakoff, 10, Rue Chabanais, F-75002 Paris, FR

Prioritet: 2002.11.29, GB, nr 3009079.

Anmerking: Registreringen er en variant av reg.nr. 78447, 78448 og 78449.

**Reg.nr: 78447**

Søkn.nr: 20020762

Allm. tilgj.: 2003.05.29

Kunngjort: 2005.01.31

Inngitt: 2002.12.09

Reg.dat: 2005.01.06

Reg. gjelder til: 2007.12.09



Produkt: Dameklokke, klasse 10-02.

Innehaver: Asprey Holdings Ltd, 167 New Bond Street, London W1S 4AS, England, GB

Fullmektig: Bryn Aarflot AS, Postboks 449 Sentrum, 0104 Oslo, NO

Designer: Thierry de Baschmakoff, 10, Rue Chabanais, F-75002 Paris, FR

Prioritet: 2002.11.29, GB, nr, 3009081.

Anmerking: Registreringen er en variant av reg.nr. 78446, 78448 og 78449.

**Reg.nr: 78448**

Søkn.nr: 20020763

Inngitt: 2002.12.09

Allm. tilgj.: 2003.05.29

Reg.dat: 2005.01.06

Kunngjort: 2005.01.31

Reg. gjelder til: 2007.12.09

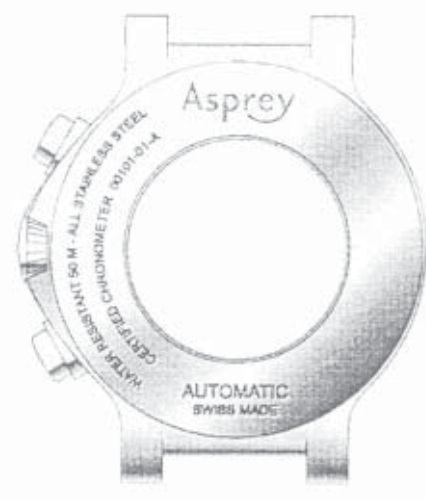
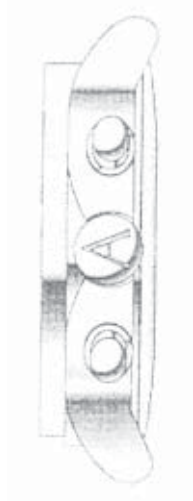

Produkt: Klokke med kronometer, klasse 10-02.

Innehaver: Asprey Holdings Ltd, 167 New Bond Street, London W1S 4AS, England, GB

Fullmektig: Bryn Aarflot AS, Postboks 449 Sentrum, 0104 Oslo, NO

Designer: Thierry de Baschmakoff, 10, Rue Chabanais, F-75002 Paris, FR

Prioritet: 2002.11.29, GB, nr 3009080.

Anmerkning: Registreringen er en variant av reg.nr. 78446, 78447 og 78449.

**Reg.nr: 78449**

Søkn.nr: 20020764

Inngitt: 2002.12.09

Allm. tilgj.: 2003.05.29

Reg.dat: 2005.01.06

Kunngjort: 2005.01.31

Reg. gjelder til: 2007.12.09



Produkt: Klokke, klasse 10-02.

Innehaver: Asprey Holdings Ltd, 167 New Bond Street, London W1S 4AS, England, GB

Fullmektig: Bryn Aarflot AS, Postboks 449 Sentrum, 0104 Oslo, NO

Designer: Thierry de Baschmakoff, 10, Rue Chabanais, F-75002 Paris, FR

Prioritet: 2002.11.29, GB, nr 3009082.

Anmerkning: Registreringen er en variant av reg.nr. 78446, 78447 og 78448.

**Reg.nr: 78450**

Søkn.nr: 20030674

Inngitt: 2003.12.01

Allm. tilgj.: 2004.06.01

Reg.dat: 2005.01.07

Kunngjort: 2005.01.31

Reg. gjelder til: 2008.12.01



1.1

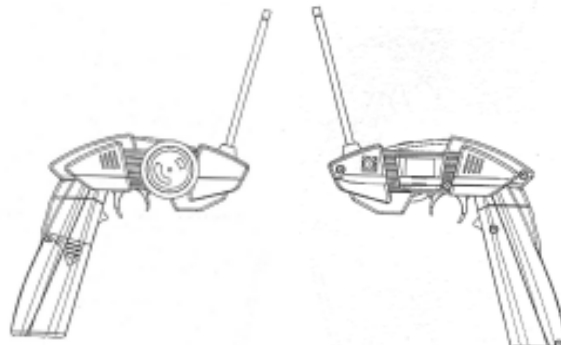

1.2

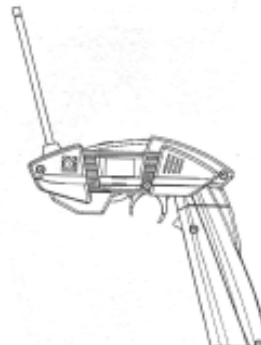

1.3

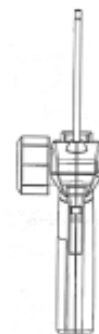

1.4

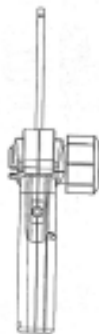

1.5



1.6

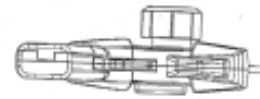

1.7



1.8



1.9

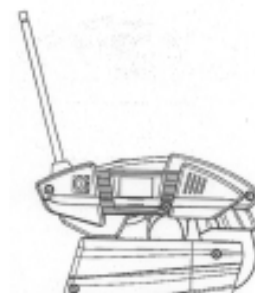

1.10

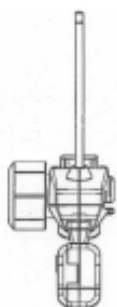

1.11

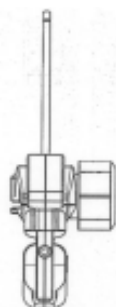

1.12

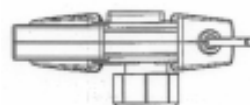

1.13



1.14



2.1



2.2



2.3



2.4



2.5



2.6



2.7

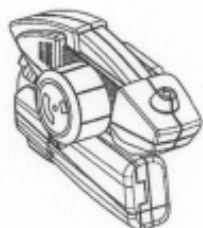

2.8

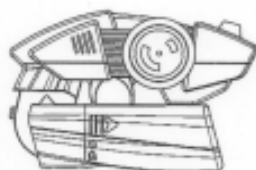

2.9



2.10

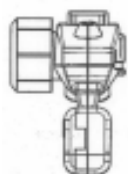

2.11

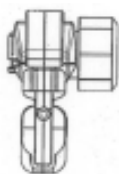

2.12

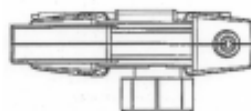

2.13



2.14

Produkt: 1. Fjernkontroll, 2. Fjernkontroll, klasse 14-03.

Innehaver: Nikko Co Ltd, 15-15, Kameari 5-chome, Katsushika-ku, 125-0061 Tokyo, JP

Fullmektig: Tandbergs Patentkontor AS, Postboks 7085 Majorstua, 0306 Oslo, NO

Designer: Hiroshi Takahashi, c/o Nikko Co Ltd, 15-15 Kameari 5-chome, Katsushika-ku, 125-0061 Tokyo, JP, Tooru Yamamoto, c/o Nikko Co Ltd, 15-15 Kameari 5-chome, Katsushika-ku, 125-0061 Tokyo, JP

Anmerkning: Registreringen gjelder samregistrering.

**Reg.nr: 78451**

Søkn.nr: 20030288

Inngitt: 2003.05.14

Allm. tilgj.: 2003.05.14

Reg.dato: 2005.01.11

Kunngjort: 2005.01.31

Reg. gjelder til: 2008.05.14

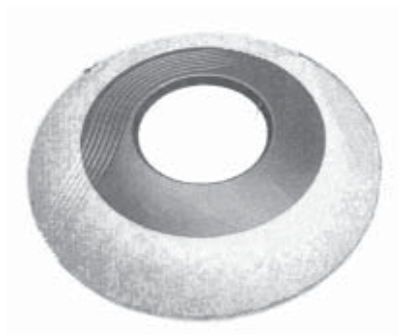

Produkt: Oppvarmingsenhet for stetoskop, klasse 24-02.  
Innehaver: Per Erik Stribolt Halvorsen, Frognerveien 62, 0266 Oslo, NO  
Designer: Abry Industrial Design AS, Inkognitogaten 1, 0258 Oslo, NO

---

**Reg.nr: 78452**

Søkn.nr: 20040045

Inngitt: 2004.02.04

Allm. tilgj.: 2004.08.04

Reg.dato: 2005.01.11

Kunngjort: 2005.01.31

Reg. gjelder til: 2009.02.04



Produkt: Sjokoladestykke, klasse 1-01.  
Innehaver: Société des Produits Nestlé SA, Case postale 353, 1800 Vevey, CH  
Fullmektig: Zacco Norway AS, Postboks 765 Sentrum, 0106 Oslo, NO  
Designer: Aline Lucena Mor, c/o Nestlé York PTC, P.O.Box 204, Haxby Road, Y0911XY York, GB  
Thierry D Fiaux, c/o Nestlé York PTC, P.O.Box 204, Haxby Road, Y0911XY York, GB

**Reg.nr: 78453**

Søkn.nr: 20030567

Allm. tilgj.: 2003.10.28

Kunngjort: 2005.01.31

Inngitt: 2003.10.28

Reg.dat: 2005.01.11

Reg. gjelder til: 2008.10.28



1.1



2.1



3.1

Produkt: 1. Nettside, 2. Nettside, 3. Nettside, klasse 14-04.  
Innehaver: Tvette AS, Postboks 894, 1670 Kråkerøy, NO  
Designer: Alexander Tvette, Postboks 894, 1670 Kråkerøy, NO  
Hege Sivertsen, Postboks 894, 1670 Kråkerøy, NO  
Anmerkninger: Designen er i farger (Design nr. 2).  
Registreringen gjelder samregistrering.

**Reg.nr: 78454**

Søkn.nr: 20030615

Allm. tilgj.: 2003.11.12

Kunngjort: 2005.01.31

Inngitt: 2003.11.11

Reg.dat: 2005.01.13

Reg. gjelder til: 2008.11.11

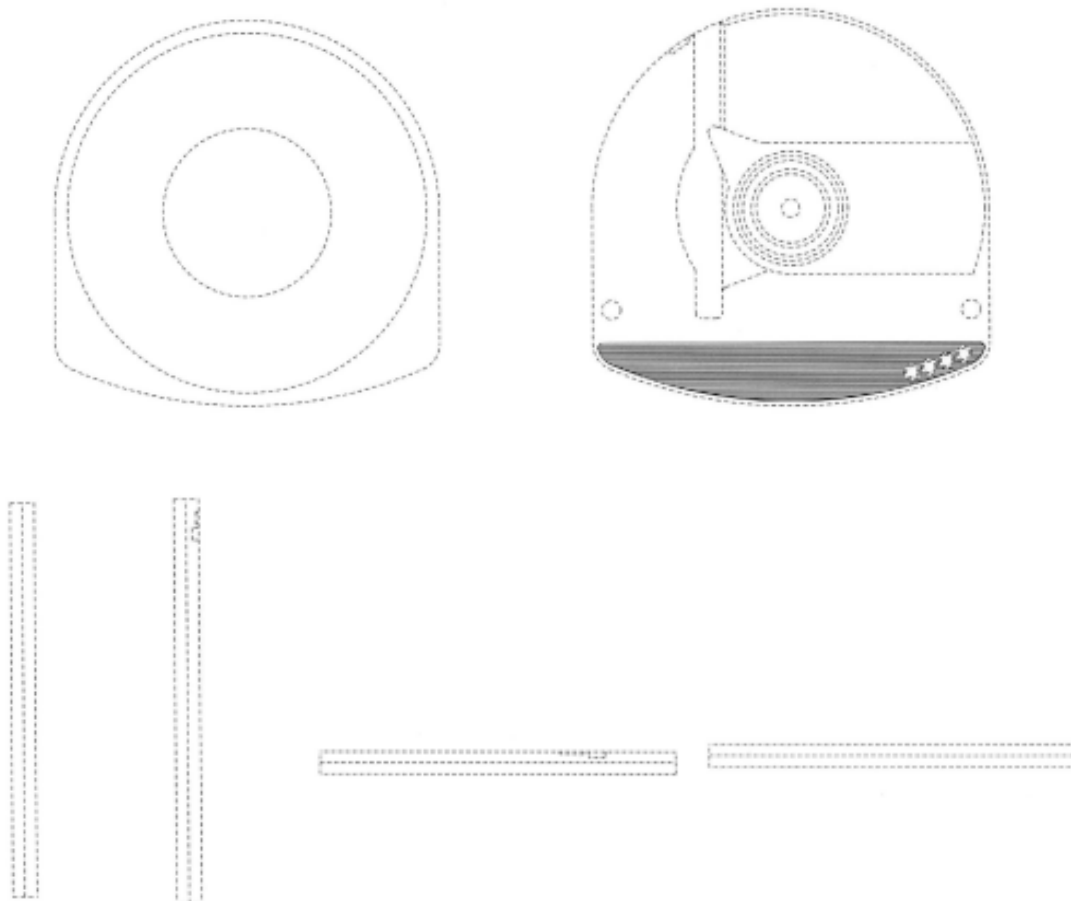

Produkt: Delutseende av disk-kassett, klasse 14-99.

Innehaver: Sony Computer Entertainment Inc, 2-6-21, Minami-Aoyama, Minato-ku, 107-0062 Tokyo, JP

Fullmektig: Tandbergs Patentkontor AS, Postboks 7085 Majorstua, 0306 Oslo, NO

Designer: Teiyu Goto, c/o Sony Corp, 7-35, Kitashinagawa 6-chome, Shinagawa-ku, Tokyo, JP

Prioritet: 2003.05.12, JP, 200316985

**Reg.nr: 78455**

Søkn.nr: 20030452

Inngitt: 2003.08.26

Allm. tilgj.: 2004.02.26

Reg.dato: 2005.01.13

Kunngjort: 2005.01.31

Reg. gjelder til: 2008.08.26

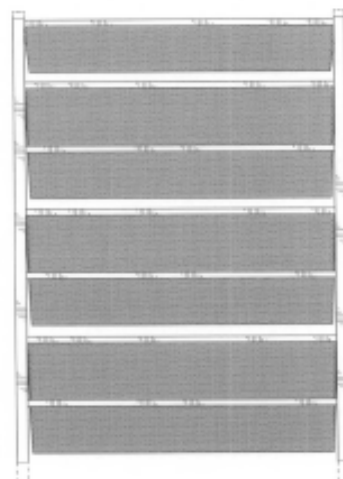
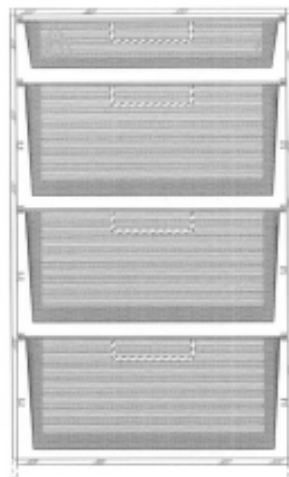

Produkt: Skuffenheter i ramme, klasse 6-04.  
Innehaver: Design Ideas Ltd, 2521 Stockyard Road, IL62708 Springfield, US  
Fullmektig: Zacco Norway AS, Postboks 765 Sentrum, 0106 Oslo, NO  
Designer: Neil Post, 1404 South State Street, IL62704 Springfield, US  
Chris Hardy, 1700 Bates Avenue, IL62704 Springfield, US  
Prioritet: 2003.05.07, US, 181262



**Reg.nr: 78456**

Søkn.nr: 20040037

Inngitt: 2004.02.02

Allm. tilgj.: 2004.02.02

Reg.dat: 2005.01.13

Kunngjort: 2005.01.31

Reg. gjelder til: 2009.02.02

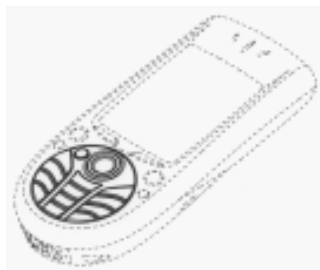

1.1



1.2



2.1



2.2

Produkt: 1. Tastaturarrangement til mobiltelefon, 2. Tastaturarrangement til mobiltelefon, klasse 14-03.

Innehaver: Nokia Corp, Keilalahdentie 4, 02150 Esbo, FI

Fullmektig: AS Bergen Patentkontor, Postboks 1998 Nordnes, 5817 Bergen, NO

Designer: Anthony Dalby, Chandos Avenue 30, W54ER Ealing, London, GB

Kim Joonsuh, 4895 Lazio Way, CA91377 Oak Park, US

Prioritet: 2003.08.01, US, 187405

Anmerkning: Registreringen gjelder samregistrering.

**Reg.nr: 78457**

Søkn.nr: 20040029

Inngitt: 2004.01.28

Allm. tilgj.: 2004.01.28

Reg.dat: 2005.01.13

Kunngjort: 2005.01.31

Reg. gjelder til: 2009.01.28

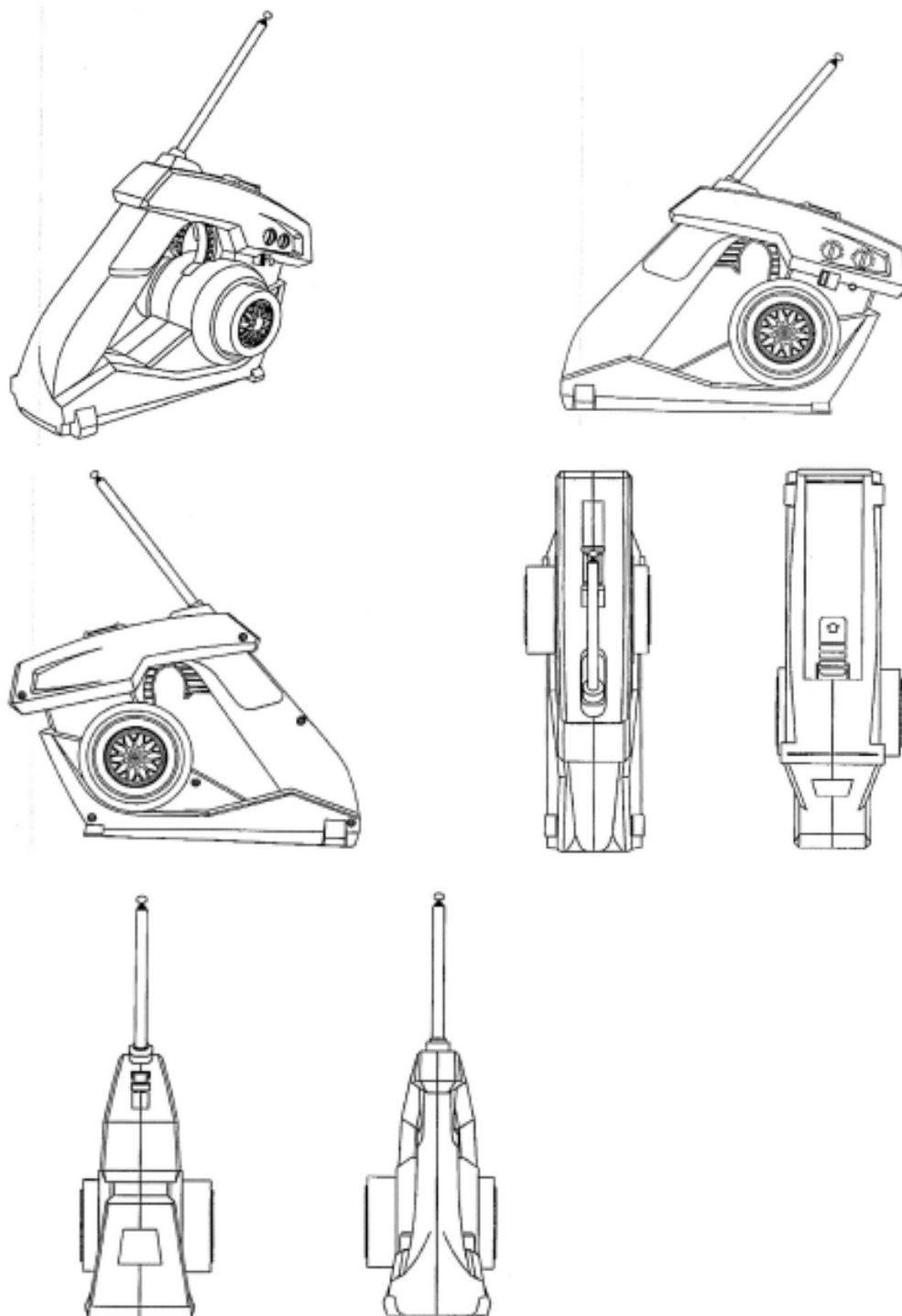

Produkt: Fjernkontroll, klasse 14-03.

Innehaver: Nikko Electronics Bhd, Suite 7.21 &amp; 7.22 7th Floor, Imbi Plaza Jalan Imbi, 55100 Kuala Lumpur, MY

Fullmektig: Tandbergs Patentkontor AS, Postboks 7085 Majorstua, 0306 Oslo, NO

Designer: Lim Ming Wei, c/o Nikko Electronics Bhd, Penang Factory, Plot 497 Prai Free Trade Zone, Prai Industrial Estate, 13600 Prai Penang, MY

**Reg.nr: 78458**

Søkn.nr: 20030083

Allm. tilgj.: 2003.02.14

Kunngjort: 2005.01.31

Inngitt: 2003.02.11

Reg.dat0: 2005.01.13

Reg. gjelder til: 2008.02.11



1.1



1.2



1.3



2.1



2.2

Produkt: 1. Mattilberedningsenhet med vifte, klasse 7-02 og 23-04; 2. Mattilberedningsenhet, klasse 7-02.

Innehaver: Electrolux Professional SpA, Via Cesare Battisti, 12, I-31015 Conegliano, IT

Fullmektig: Onsagers AS, Postboks 6963 St Olavs Plass, 0130 Oslo, NO

Designer: Luciano Valboni, Via dei Mille 23, I-31030 S Vendemiano (TV), IT

Prioritet: 2002.08.14, DE, nr 40206897.1.

Anmerkning: Registreringen gjelder samregistrering.

## Fornyelse av registreringer

Reg.nr: 72393                                      Fornyhet til: 2010.01.26  
Innehaver: Masterfoods GmbH, D-27281 Verden/Aller, DE  
Fullmektig: Onsagers AS, Postboks 6963 St Olavs Plass, 0130 Oslo, NO

Reg.nr: 72429                                      Fornyhet til: 2010.02.01  
Innehaver: SEB SA, Les 4 m, Chemin du Petit-Bois, F-69130 Ecully, FR  
Fullmektig: Zacco Norway AS, Postboks 765 Sentrum, 0106 Oslo, NO

Reg.nr: 72534                                      Fornyhet til: 2010.01.30  
Innehaver: Olofsfors AB, Olofsfors 11, S-914 91 Nordmaling, SE  
Fullmektig: Zacco Norway AS, Postboks 765 Sentrum, 0106 Oslo, NO

Reg.nr: 72617                                      Fornyhet til: 2010.01.31  
Innehaver: Zebra Co, Ltd, 2-9, Higashigoken-cho, Shinjuku-ku, Tokyo, JP  
Fullmektig: J.K. Thorsens Patentbureau AS, Postboks 9276 Grønland, 0134 Oslo, NO

Reg.nr: 72632                                      Fornyhet til: 2010.01.04  
Innehaver: Unilever NV, Weena 455, NL-3013 AL Rotterdam, NL  
Fullmektig: Zacco Norway AS, Postboks 765 Sentrum, 0106 Oslo, NO

Reg.nr: 73259                                      Fornyhet til: 2010.02.10  
Innehaver: SA des Eaux Minerales d'Evian, 22, avenue des Sources, F-74503 Evian, FR  
Fullmektig: Zacco Norway AS, Postboks 765 Sentrum, 0106 Oslo, NO

Reg.nr: 75666                                      Fornyhet til: 2010.01.03  
Innehaver: Perstorp Plastic Systems AB, S-284 80 Perstorp, SE  
Fullmektig: Onsagers AS, Postboks 6963 St Olavs Plass, 0130 Oslo, NO

Reg.nr: 75790                                      Fornyhet til: 2010.01.04  
Innehaver: Koninklijke Philips Electronics NV, Groenewoudseweg 1, NL-5621 BA Eindhoven, NL  
Fullmektig: Zacco Norway AS, Postboks 765 Sentrum, 0106 Oslo, NO

Reg.nr: 75945                                      Fornyhet til: 2010.02.28  
Innehaver: Henkel KGaA, Henkelstrasse 67, D-40589 Düsseldorf, DE  
Fullmektig: Zacco Norway AS, Postboks 765 Sentrum, 0106 Oslo, NO

Reg.nr: 75983                                      Fornyhet til: 2010.02.15  
Innehaver: Skoda Auto AS, Václava Klementa 869, 293 60 Mladá Boleslav, CZ  
Fullmektig: Tandbergs Patentkontor AS, Postboks 7085 Majorstua, 0306 Oslo, NO

Reg.nr: 76026                                  Fornyhet til: 2010.01.31  
Innehaver: Dart Industries Inc, 14901 S Orange Blossom Trail, Orlando, FL 32837, US  
Fullmektig: Zacco Norway AS, Postboks 765 Sentrum, 0106 Oslo, NO

Reg.nr: 76031                                  Fornyhet til: 2010.03.24  
Innehaver: Produkt Johan AB, Box 216, S-186 24 Vallentuna, SE  
Fullmektig: Onsagers AS, Postboks 6963 St Olavs Plass, 0130 Oslo, NO

Reg.nr: 76042                                  Fornyhet til: 2010.02.11  
Innehaver: Henkel KGaA, Henkelstrasse 67, D-40589 Düsseldorf, DE  
Fullmektig: Zacco Norway AS, Postboks 765 Sentrum, 0106 Oslo, NO

Reg.nr: 76138                                  Fornyhet til: 2010.01.17  
Innehaver: Masterfoods AS, Hovfaret 13, 0275 Oslo, NO  
Fullmektig: Onsagers AS, Postboks 6963 St Olavs Plass, 0130 Oslo, NO

Reg.nr: 76189                                  Fornyhet til: 2010.02.18  
Innehaver: iGuzzini Illuminazione SrL, SS 77 Km 102, I-62019 Recanati, Macerata, IT  
Fullmektig: Zacco Norway AS, Postboks 765 Sentrum, 0106 Oslo, NO

Reg.nr: 76190                                  Fornyhet til: 2010.02.18  
Innehaver: iGuzzini Illuminazione SrL, SS 77 Km 102, I-62019 Recanati, Macerata, IT  
Fullmektig: Zacco Norway AS, Postboks 765 Sentrum, 0106 Oslo, NO

Reg.nr: 76191                                  Fornyhet til: 2010.02.18  
Innehaver: iGuzzini Illuminazione SrL, SS 77 Km 102, I-62019 Recanati, Macerata, IT  
Fullmektig: Zacco Norway AS, Postboks 765 Sentrum, 0106 Oslo, NO

Reg.nr: 76366                                  Fornyhet til: 2010.02.18  
Innehaver: iGuzzini Illuminazione SrL, SS 77 Km 102, I-62019 Recanati, Macerata, IT  
Fullmektig: Zacco Norway AS, Postboks 765 Sentrum, 0106 Oslo, NO